

VT(3,6 ÷ 17,5)-2

Weight: ≤ 22 kg

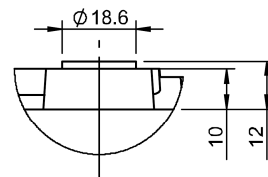

DETAIL A
SCALE 1 : 2

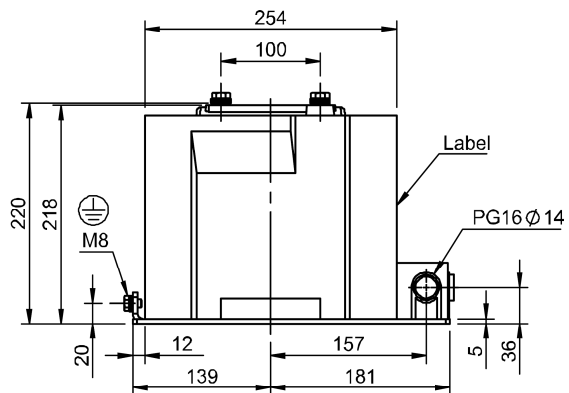