

FT24-2.40N
Weight: ≤ 76 kg

Primary fuse connection
2 x M10 x 20 ISO 4017

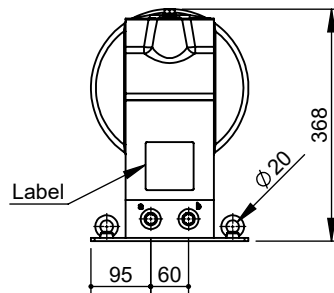

Secondary connection
2 x M10 x 20
ISO 4017

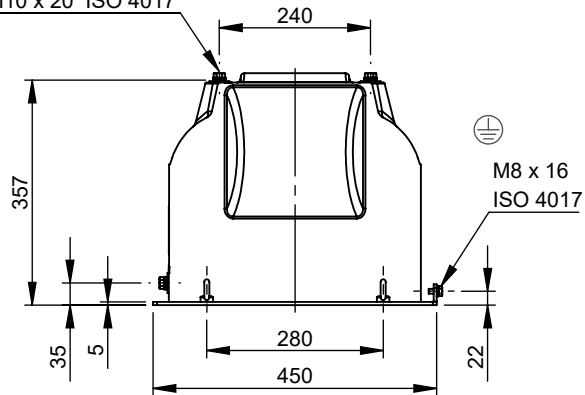